

omniace
RA3100

DATA ACQUISITION SYSTEM



All data recorded in Omniace
High-speed, long-term recording of phenomena
on large-capacity storage media

Data Acquisition System

omniace RA3100

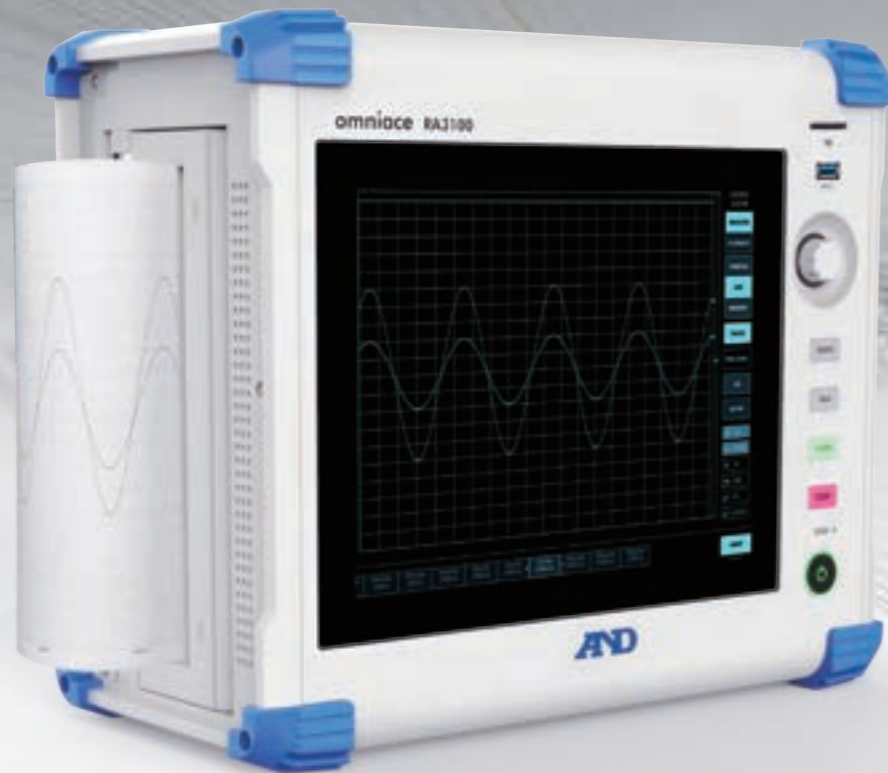

Omniace RA3100 is a data acquisition system for research, development, and field maintenance, which enables accurate and long-term measurement of high-speed switching waveforms, even in severely noisy environments, in electric automobiles, electronic appliances, railroad cars, and solar power generation systems utilizing inverter control technology that has become widespread in recent years.

- Multi-channel input**
Max 36ch (analog input)
Max 144ch (logic input)
- High speed sampling**
Max 20MS/s
- Long-term recording**
Memory capacity 4GB
(when 18 channels are used, 20MS/s, 5 seconds)
256GB SSD
(1MS/s, 59 minutes when using 36 channels.)
- High-speed and High-definition printing**
Maximum chart speed 100mm/s
Back up to SSD even if there is no chart paper.
- Various recording method**
Recording to Memory, SSD, and Printer.
All data can be measured simultaneously.
- Input modules**
Voltage, High-Voltage(1,000V), Temperature,
Strain, Acceleration, Pulse and Logic Input Module
- Excellent visibility and operability**
12.1-inch LCD with touch panel provide you excellent
visibility and operability.
- Back scrolling**
Data being measured can be played back without
ending the measurement.
- Various Monitor Displays**
Y-T waveform, X-Y waveform, and FFT analysis can
be displayed on the LCD monitor during measurement.

High-speed Sampling and High-definition Measurement at 20MS/s with 18ch for 5 seconds

"The 2ch High-Speed Voltage Module" is an input module for high-speed sampling at the highest level of the series. Includes the ability for a sampling rate of 20MS/s, input voltage up to $\pm 500V$, and 14bit resolution. 9 modules can be installed in the main unit, allowing for 18-channel high-speed memory recording.

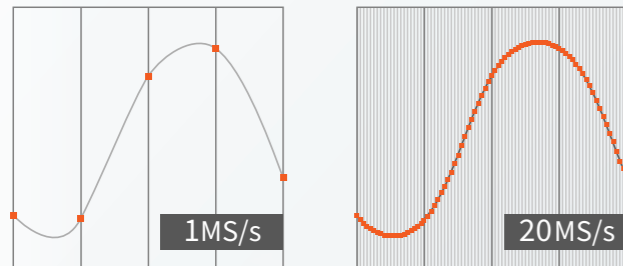

Recordable time into memory

	2ch	8ch	18ch
20 MS/s	50 sec	10 sec	5 sec
10 MS/s	1 min 40 sec	20 sec	10 sec
5 MS/s	3 min 20 sec	40 sec	20 sec
2 MS/s	8 min 20 sec	1 min 40 sec	50 sec
1 MS/s	16 min 40 sec	3 min 20 sec	1 min 40 sec
500 kS/s	33 min 20 sec	6 min 40 sec	3 min 20 sec
10 kS/s	27 hrs 46 min 40 sec	5 hrs 33 min 20 sec	2 hrs 46 min 40 sec
5 kS/s	55 hrs 33 min 20 sec	11 hrs 06 min 40 sec	5 hrs 33 min 20 sec
2 kS/s	138 hrs 53 min 20 sec	27 hrs 46 min 40 sec	13 hrs 53 min 20 sec
1 kS/s	277 hrs 46 min 40 sec	55 hrs 33 min 20 sec	27 hrs 46 min 40 sec

Long-term Recording

Various recording speeds, multiple channels, and a high-capacity storage medium to support a large amount of data are included as standard.

Recording desired signal accurately without missing detailed changes.

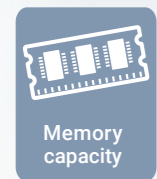

Memory capacity

4GB

(when 18 channels are used, 20MS/s, 5 seconds)

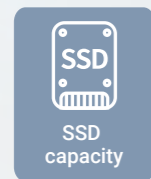

SSD capacity

256GB

(when 36 channels are used, 1MS/s, 59 minutes)



High-speed, High-definition Printing

High-resolution waveform printing at high speeds (100mm/s) is possible.

Even if the chart paper runs out, recorded data is backed up to the SSD and can be printed out later.

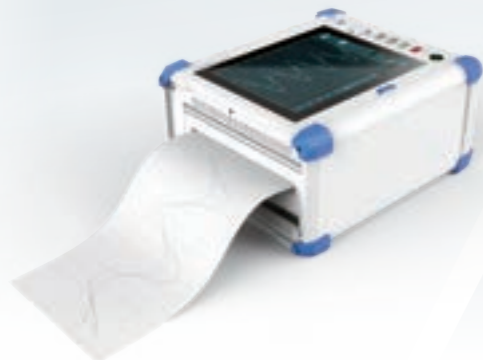

Multi-channel Input

"The 4ch Voltage Module" allows 4-channel input with a single unit. 9 modules can be installed in the main unit, allowing 36-channel recording.

"The 16-channel Logic Module" allows 16-channel logic signal input with a single unit. 9 modules can be installed in the main unit, allowing 144-channel logic signal recording.

Max 36ch
with analog input

Max 144ch
with logic input

Excellent Visibility and Operability

The LCD display with touch panel allows zoom in and out, and scrolling through the waveform simply, allowing a dynamic waveform drawing and operability like a smartphone.

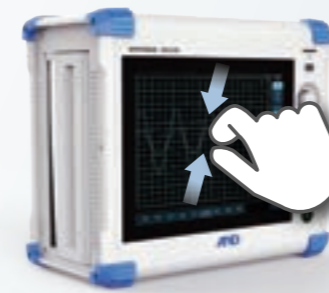

Pinch-in (zoom out)



Pinch-out (zoom in)

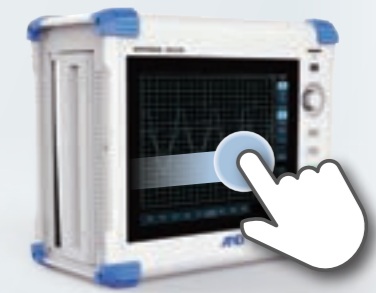

Swipe (scroll)

Input Module

Up to 9 modules can be installed in the main unit. Various modules for high-speed voltage, high-accuracy voltage, logic input, temperature measurement, and remote control are available.

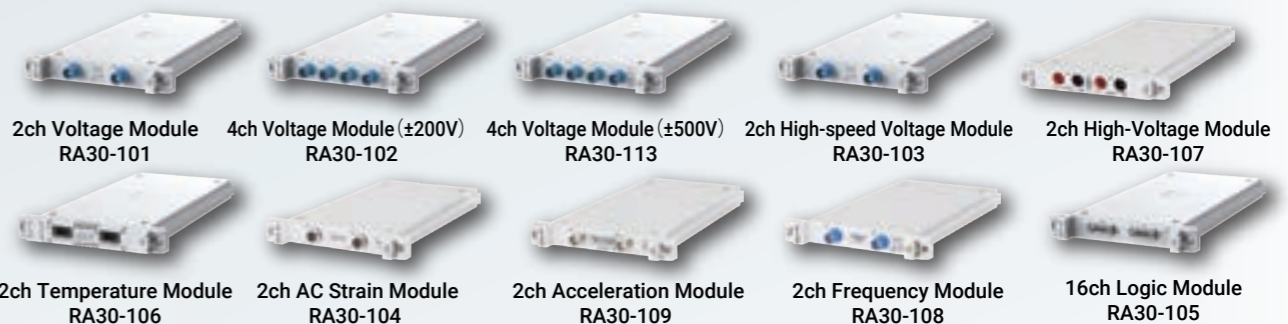

Module Name and Model	Channels	Sampling Rate	Input	Specifications
2ch Voltage Module RA30-101	2ch	1MS/s	Voltage $\pm 500V$	Measure high-speed voltage measurement with anti-aliasing filters
4ch Voltage Module RA30-102	4ch	1MS/s	Voltage $\pm 200V$	Multi-channel voltage measurement
4ch Voltage Module RA30-113	4ch	1MS/s	Voltage $\pm 500V$	Multi-channel voltage measurement
2ch High-speed Voltage Module RA30-103	2ch	20MS/s	Voltage $\pm 500V$	High-speed voltage measurement
2ch High Voltage Module RA30-107	2ch	1MS/s	Voltage $\pm 1,000V$	Module to measure high voltages of $\pm 1,000V$
16ch Logic Module RA30-105	16ch	1MS/s	Contact, Voltage	Contact, Voltage signal measurement
2ch Temperature Module RA30-106	2ch	1.5ms	Thermocouple : K, E, J, T, N, R, S, B, C RTD: Pt100, Pt1000	Measurement of temperature with a thermocouple and RTD
2ch AC Strain Module RA30-104	2ch	100kS/s	Strain gauge, Strain gauge transducer	Module to measure stress, load, displacement, pressure, torque, and acceleration
2ch Acceleration Module RA30-109	2ch	1MS/s	Piezoelectric acceleration transducer (charge output, built-in amplifier)	Module to measure acceleration, speed and displacement
2ch Frequency Module RA30-108	2ch	1MS/s	Voltage $\pm 500V$	Input module capable of measuring period, rotation speed, number of pulses, etc., of input signals

Back Scrolling

Press the [PAUSE] button during recording to playback recorded data while recording.

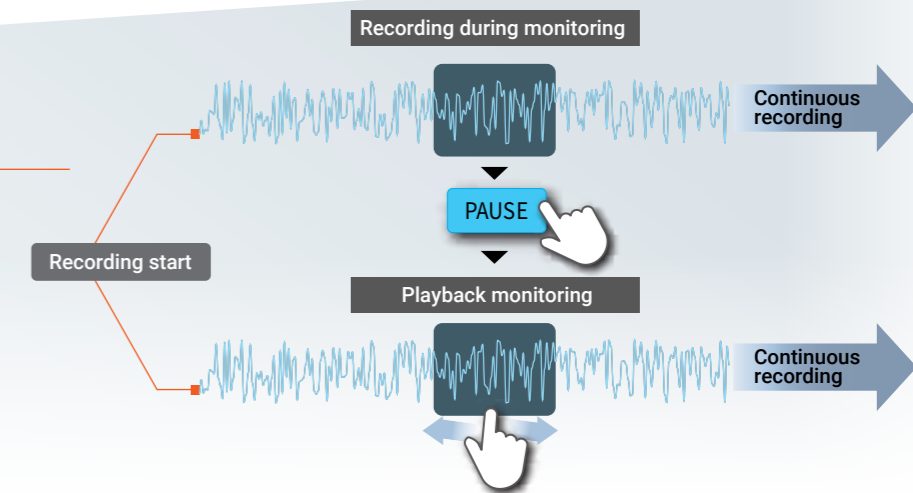

Various Recording Method

"Memory", "SSD", and "Printer" are provided as data recording destinations. Data recording can be performed at three destinations at the same time. This can be selected freely depending on the measurement purposes.



Memory mode records data in the internal memory (4GB) at high speed (Max: 20MS/s). In addition, measurement can be performed under a variety of conditions using a variety of trigger functions.

After the input data is recorded in the memory, it is automatically saved to SSD.

Sampling speed : 20MS/s to 10S/min (depending on the input module)

Memory capacity : 4GB (2G point/ch)

Memory divisions : 1 to 200 divisions

Recording length : 2,000 to 2G points/ch (1-2-5 step)

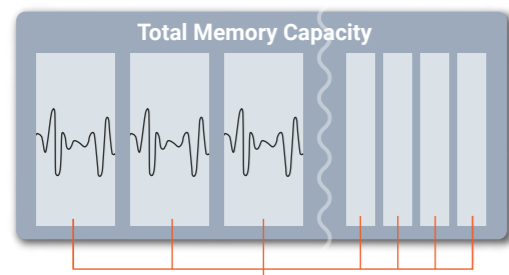

Memory Block Segment 1~200

Recordable Time on Memory

	2ch	8ch	18ch	36ch
20MS/s	50sec	10sec	5sec	—
10MS/s	1 min 40sec	20sec	10sec	5sec
5MS/s	3min 20sec	40sec	20sec	10sec
2MS/s	8min 20sec	1 min 40sec	50sec	25sec
1MS/s	16min 40sec	3min 20sec	1 min 40sec	50sec
500kS/s	33min 20sec	6min 40sec	3min 20sec	1 min 40sec
10kS/s	27hrs 46min 40sec	5hrs 33min 20sec	2hrs 46min 40sec	1hrs 23min 20sec
5kS/s	55hrs 33min 20sec	11hrs 06min 40sec	5hrs 33min 20sec	2hrs 46min 40sec
2kS/s	138hrs 53min 20sec	27hrs 46min 40sec	13hrs 53min 20sec	6hrs 56min 40sec
1kS/s	277hrs 46min 40sec	55hrs 33min 20sec	27hrs 46min 40sec	13hrs 53min 20sec

All data can be measured simultaneously.

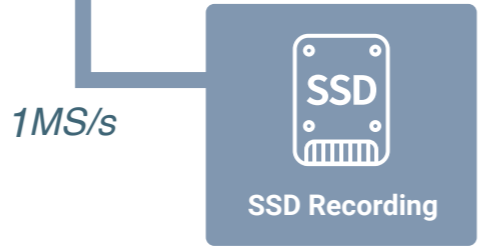

Long-term of data can be recorded to the internal SSD. High-speed recording of up to 1MS/s is possible when using 36ch. Since it is stored as digital data, data can be analyzed after recording and data can be managed for a long period of time.

Input data is saved directly to SSD.

Sampling speed : 1MS/s to 10S/min (depending on the input module)

SSD capacity : 256GB

Maximum recording time : 100 days

Data format : Normal data, Peak data

Recordable Time on SSD^{*1}

Sample speed	2ch	8ch	18ch	36ch
*2 1MS/s	11hrs 46min 40sec	3hrs 55min 33sec	1hrs 51min 34sec	57min 17sec
500kS/s	23hrs 33min 21sec	7hrs 51min 07sec	3hrs 43min 09sec	1hrs 54min 35sec
200kS/s	2day 11hrs 20min 02sec	19hrs 37min 48sec	9hrs 17min 54sec	4hrs 46min 29sec
100kS/s	4day 21hrs 46min 49sec	1day 15hrs 15min 36sec	18hrs 35min 48sec	9hrs 32min 59sec
50kS/s	9day 19hrs 33min 39sec	3day 06hrs 31min 13sec	1day 13hrs 11min 37sec	19hrs 05min 58sec
20kS/s	24day 12hrs 54min 09sec	8day 04hrs 18min 03sec	3day 20hrs 59min 04sec	1day 23hrs 44min 55sec
10kS/s	49day 01hrs 48min 19sec	16day 08hrs 36min 06sec	7day 17hrs 58min 09sec	3day 23hrs 29min 51sec
5kS/s	98day 03hrs 36min 38sec	32day 17hrs 12min 12sec	15day 11hrs 56min 18sec	7day 22hrs 59min 43sec
2kS/s	100day	81day 19hrs 00min 31sec	38day 17hrs 50min 46sec	19day 21hrs 29min 19sec
1kS/s	100day	100day	77day 11hrs 41min 33sec	39day 18hrs 58min 38sec
500S/s	100day	100day	100day	79day 13hrs 57min 16sec
200S/s	100day	100day	100day	100day

*1 If you select peak data as the data type, the time will be 1/2 of the above time.
*2 A sample rate of 1MS/s is not available when peak data is selected as the data type.

Window Recording

Endless recording is possible by specifying the ring buffer area (maximum 2G points/ch) as the window recording time. If you do not know when an abnormality will occur, you may miss the abnormal data if you set the recording time and measure. By ringing the recording area, you can always save the latest data.

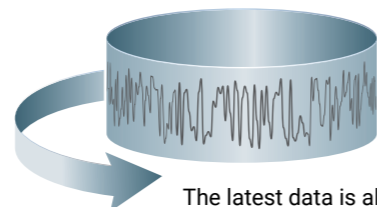

The latest data is always recorded.

100mm/s (1kS/s)

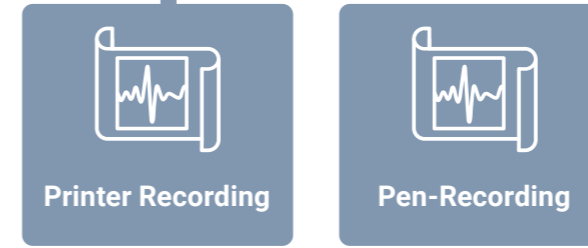

Input data is printed directly on the chart paper at high speed (Max 100mm/s). Data printed on chart paper is also stored digitally on the SSD, so even if the chart paper runs out, the data can be printed out later.

Pen recording is only recorded on the recording paper, measurement data is not saved. Input module and paper feed speed can be set during recording.

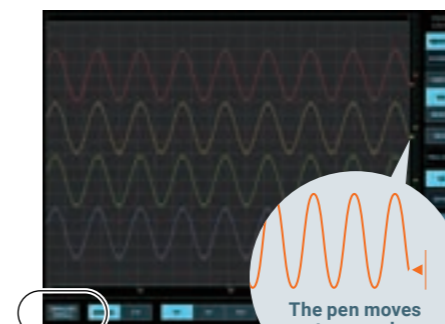
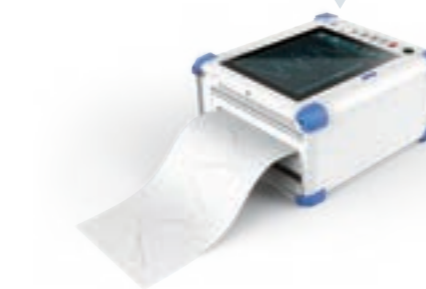

Chart Speed

The pen moves to record the wave form.



Recording Specifications

Number of recorded signals: 48 channels
Chart speed: 100mm/s(1kS/s)~1mm/min(10S/min)
Recording resolution: 20 to 80dots/mm (time axis)
8dots/mm (amplitude axis)

Selectable for SSD Recording

Normal Data and Peak Data

Omniace is a digital recorder that performs analog to digital conversion on all inputs and records those signals. Due to the relationship between the speed of analog to digital conversion and the frequency component of the input signal, the data may or may not be measured correctly.

Normal Data

Normal data is recorded at each designated sampling speed. (□ points)
If the signal changes too fast relative to the sampling speed, the data singular point (peak value) may not be recorded. Memory recording can measure this type of data.

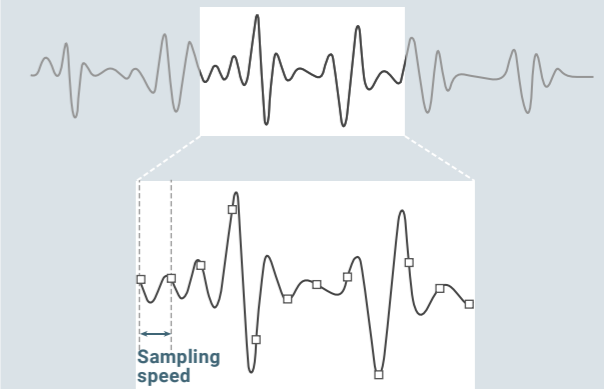

Peak Data

Peak data is sampling (■, ■, and □ points) between the designated recording speed at the fastest AD-conversion rate, and records two data points, the maximum value (■ points) and the minimum value (■ points). The amount of data can be compressed without losing the data singular point (peak value). Printer recording records data of this method on the chart paper.

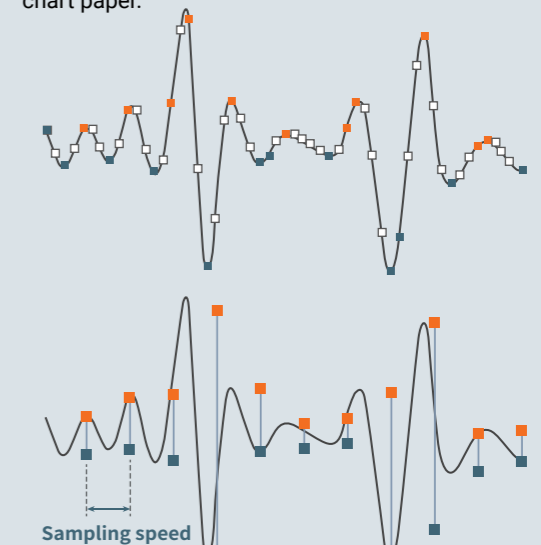

Various Monitor Displays

Input signal and recorded data can be displayed as Y-T waveform display, X-Y display, and FFT.

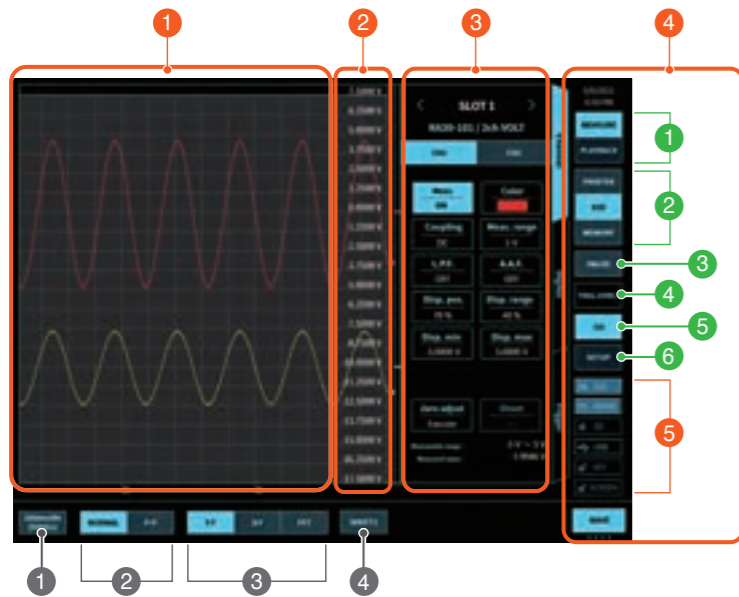

- 1 **Waveform display Area**
- 2 **Scale area**
- 3 **Submenu**
Press the [CH] key in the "Operation key area" to make settings related to the input module.
- 4 **Side menu area**
- 5 **Status display icon**
Storage medium, interface, key lock
- 6 **Chart speed switching**
- 7 **Data format of waveform display when recording to SSD**
- 8 **Monitor waveform selection**
Select Y-T waveform, X-Y waveform, or FFT analysis.
- 9 **Sheet selection**
- 10 **Monitor selection**
Measurement: Display the current input signal.
Playback: Play back saved data
- 11 **Monitoring device selection**
• Data to printer
• Data to SSD
• Data to memory
- 12 **Pause**
Pause input monitoring
- 13 **TRIG.SYNC.**
Monitor synchronized with a trigger
- 14 **CH**
Input module settings
- 15 **Settings**
Measurement conditions setting screen

Y-T Waveform Display

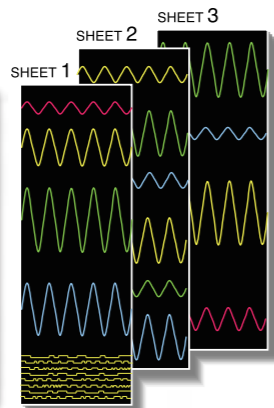
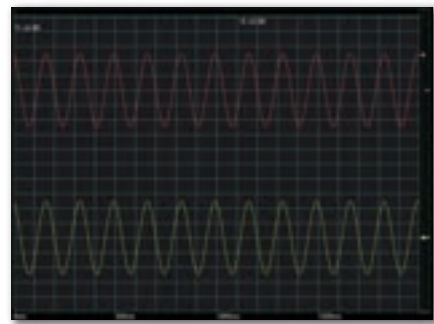

Display the measurement channels split into three sheets. Up to 48 channels of signals can be monitored on a sheet with 20 vertical/horizontal divisions. Graphs can be divided into 1 to 18 sheets and displayed.



Set the signal display width and display position.

Signals can be drawn at any position on the graph at any width. You can easily draw a 100V signal in the width of 1div.

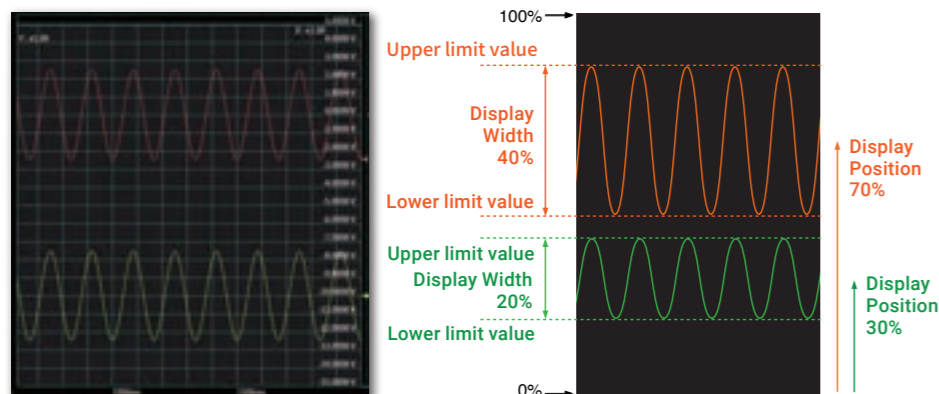

- Display Width**
Display the signals of each channel at any width. Set the width of the channel to be displayed as % out of the 100% width of the display graph.
- Display Position**
Set the position of the channel to be displayed as % out of the 100% width of the display graph.
- Scale Setting**
Set the upper limit/lower limit value of display for the display width of each channel as an input value or a physical conversion value.

X-Y waveform Display

An X-Y waveform can be drawn by specifying 4 channels for the X-axis and 4 channels for the Y-axis. The screen format can be displayed a large single screen format, or divided four screen formats for the each X and Y axis channels. The pen can also be moved up or down, and the grid can be turned on or off.

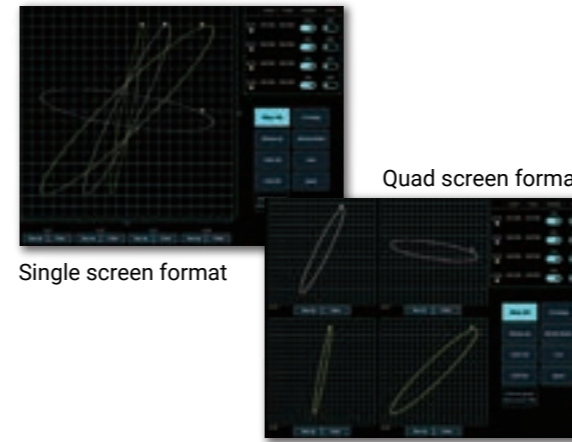

FFT Analysis

FFT analysis is performed for any two signals. The top 10 highest values can be read from the analysis results, and the value of any analysis result can be read using the cursor. (FFT analysis can be performed on normal data recorded in SSD.)

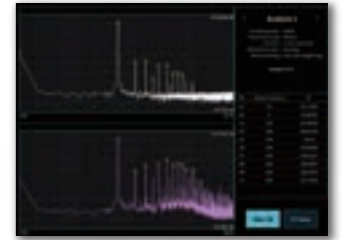

Data selection	Select from the input signal or recorded data
Sampling	1000, 2000, 5000, 10,000
Maximum analysis frequency	1/2 times of the sampling frequency
Display format	1 screen, 2 screens.
Functions	Time-Axis waveform, Linear Spectrum, RMS Spectrum, Power Spectrum, Power spectrum density, 1/1 Octave, 1/3 Octave, Transfer Function, Cross-Power Spectrum, Coherence Function
Window Functions	Hanning window, Hamming window, Rectangular window
Average processing	Time axis simple addition average, Frequency axis simple addition average, Frequency axis exponent weighted average, Frequency axis peak hold
X-axis scale	Time, Linear frequency, Log frequency, 1/1 octave, 1/3 octave
Y-axis scale	Real value area, Imaginary number area, Amplitude, Logarithmic amplitude, Auto scale or manual scale in accordance with the phase analysis results

Recording Mode Selection

Nine measurement patterns are prepared as Recording modes. "Recording Mode" can be selected from Measurement starts by manual operation, Measurement starts from a trigger signal or Repeating measurement, etc. When "Recording Mode" is selected, the necessary set-up menu is displayed and can be easily set.

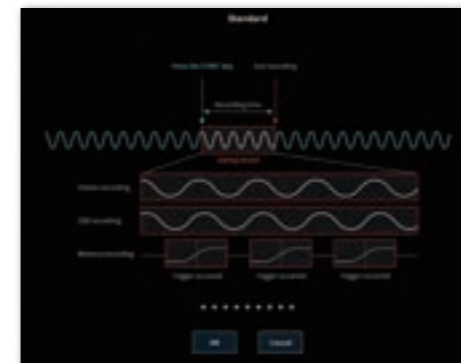

- 1 Normal record
- 2 Start time
- 3 Start trigger
- 4 Interval time (N times)
- 5 Start time + Start trigger
- 6 Start time + Interval time (N times)
- 7 Start trigger + Interval time (N times)
- 8 Start time + Start trigger + Interval time (N times)
- 9 Window recording

PC Compatibility

*1 The software can be downloaded from our website: https://www.aandd.co.jp/support/soft_download/industrial.html

Web server, FTP server

The RA3100 can be remotely operated from a web browser (operating PC). The web browser displays the same screen as the RA3100 main unit with pseudo operation panel keys (START key, etc.) to make settings and start/stop recording. Additionally, data stored on the RA3100 can be transferred to a PC.

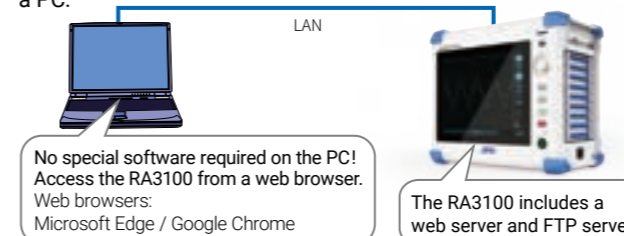

Software for displaying measurement data*1

"RA3100 Viewer" is software to display recorded data exported to external media from an RA3100 on a PC.

PC software for converting measurement data*1

The "File Converter" software can convert recorded data exported to external media from an RA3100 to CSV or ASAM MDF *2 (Ver. 4.1) files on a PC.

*2 ASAM : Association for Standardization of Automation and Measuring Systems
MDF : Measurement Data Format

Various input modules

Voltage input modules 5 types

Name	2ch Voltage Module	4ch Voltage Module	2ch High-speed Voltage Module	2ch High-Voltage Module
Model name	RA30-101	RA30-102 / RA30-113	RA30-103	RA30-107
Appearance				
Function	Input module capable of measuring ±500V voltage. Anti-aliasing filter allow for frequency analysis with no wrap-around.	This is an input module that can measure voltage on 4 channels. Using 9 slots allows measurement of up to 36 channels. The RA30-102 can measure up to ±200V, and the RA30-113 can measure up to ±500V.	This input module is capable of high-speed sampling at 20MS/s and measurement of ±500V input voltage.	This module can directly input high voltage of ±1,000V(700Vrms). Voltage waveform or RMS value can be measured.
No. of channels	2ch	4ch	2ch	2ch
Maximum input voltage	Maximum input voltage:±500V 	Maximum input voltage ±200V(RA30-102) / ±500V(RA30-113) 	Maximum input voltage:±500V 	Maximum input voltage:±1,000V
Range	500V to 0.1V	200V to 1V(RA30-102) / 500V to 2V(RA30-113)	500V to 0.1V	1,000V to 2V
Sampling speed				
A/D Resolution	16bit	16bit	14bit	16bit
Other function	With anti-aliasing filter	—	—	RMS conversion
Input cable	Insulated BNC cable (RA30-507) 	Insulated BNC cable (RA30-507) 	Insulated BNC cable (RA30-507) 	High voltage alligator clips(RA30-509-1) High-voltage connection cable (RA30-509-2)

2ch AC Strain Module RA30-104

This input module enables stress measurement using strain gauges as well as strain gauge transducers such as load cells, pressure transducers, and torque transducers. The AC bridge method can be used for measurement that is strong against external noise.

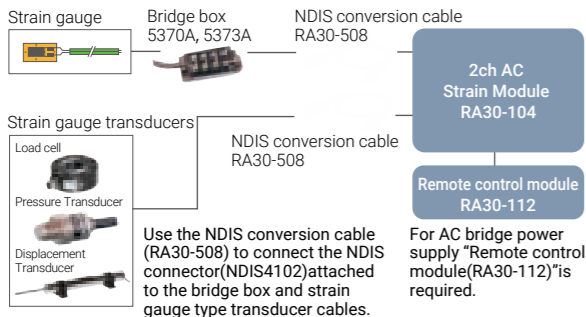

2ch Acceleration Module RA30-109

This module can measure acceleration, speed, and displacement of mechanical vibration using a piezoelectric acceleration transducer (built-in amplifier, charge output type). For mathematical functions, RMS conversion, and then envelope processing can be performed.

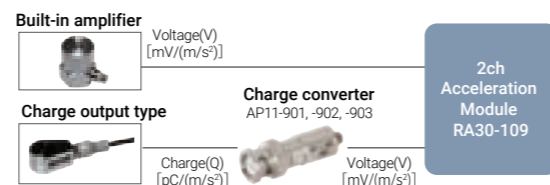

Envelope processing

Envelope processing helps to identify abnormal areas of bearings (inner rings, outer rings, and rollers/balls) by looking at the periodicity of vibrations caused by bearing flaws.

Envelope-processed signals are subjected to frequency analysis and the resulting primary frequency and information such as the size of each bearing part, the number of rollers and balls, and the shaft rotation speed can be used to infer the damaged part.

Envelope processing depiction

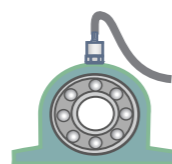
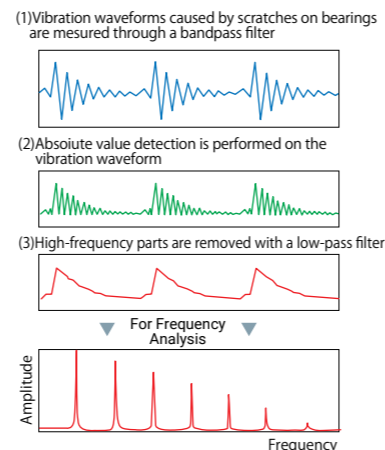

2ch Temperature Module RA30-106

An input module for a thermocouple or resistance temperature detector. Thermocouples can be used for high temperatures and wide temperature ranges, while resistance thermometers can be used to measure temperatures near room temperature with high accuracy.

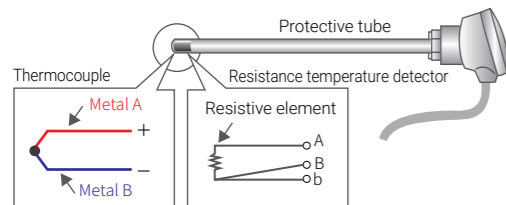

Features of Thermocouples and Resistance Temperature Detectors

Thermocouple	Advantages	Disadvantages
A sensor utilizing the phenomenon that a voltage is generated when a temperature difference is applied to the contact points at both ends of a circuit created by connecting two different types of metal wires.	Low cost, high temperature and wide temperature range (200 to 2,300°C), small temperature measurement objects, measurement in confined spaces, fast thermal response	Poor accuracy (compared to Resistance temperature detector), reference junction required
Resistance temperature detector	Advantages	Disadvantages
A sensor utilizing the phenomenon that the electrical resistance of metals changes with changes in temperature.	High accuracy (compared to Thermocouple), no reference junction required	Large form factor, slow response, narrower temperature range (200 to 850°C) than thermocouple, expensive, weak against vibration and shock

2ch Frequency Module RA30-108

Period, rotation speed, pulse count, etc. can be measured for the input pulse signal. Measurement result data such as period, rotation speed, pulse count, etc., and the input pulse signal can be saved.

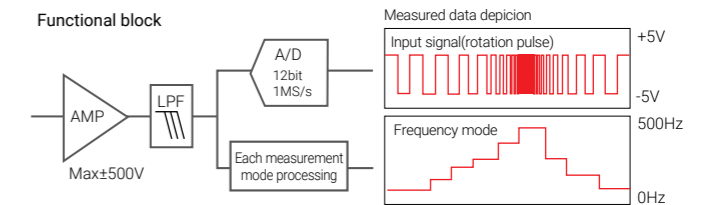

Measurement Mode

●Period

Measures the period of the measured pulse. (s: seconds)
Measures the width (Tb) from leading edge to leading edge of the pulse.

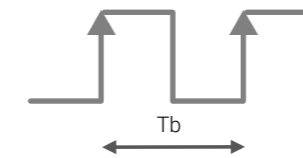

●Frequency Mode

Measure the frequency of the measured pulse. (Hz: hertz)
Calculates the period from the width (Tb) from leading edge to leading edge of the pulse.

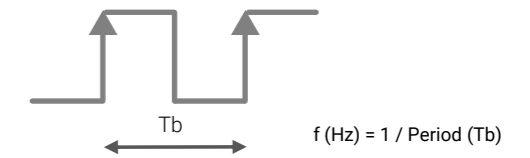

●Pulse Width Mode

Measures the pulse width (Tp) from leading edge (trailing edge) to trailing edge (leading edge) of the pulse. (s: seconds)

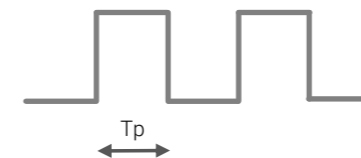

●Duty Ratio Mode

Measures the pulse ratio (Ta/Tb) from leading edge (trailing edge) to trailing edge (leading edge) of the pulse. (%)

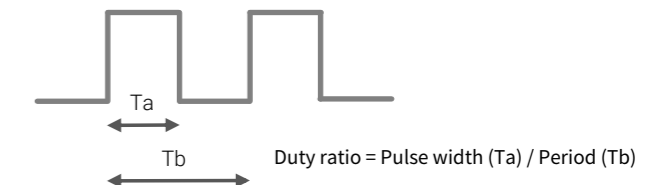

●Rotation Speed Mode

Measure the rotation speed of the measured pulse. (rpm: rotations) Rotation speed (rpm) = 60 / (Measured period x No. of pulses per revolution)
* The number of pulses per revolution can be set from 1 to 100.



The gear to the left has 11 teeth, so the number of pulses per revolution is 11.

●Power Frequency Mode

Measures fluctuations in power supply frequency (50/60/400Hz).

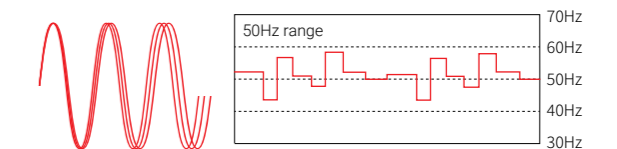

●Range of Variation Mode

Measures the variation from the measured frequency and the set center frequency. (%)
Range of variation (%) = Measurement frequency / Center frequency

The illustration below shows the range of variation from frequency analysis data.

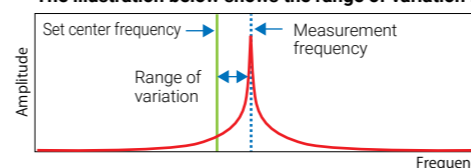

This module detects the frequency from the input pulse and calculates the variation from the set center frequency value. Changes in range of variation can be measured as sequential data.

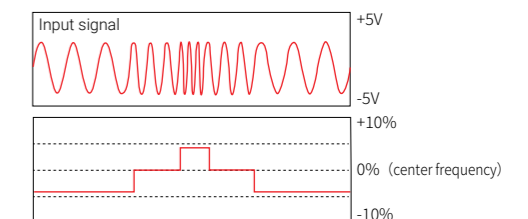

Pulse Count Mode

Integrates the number of pulses confirmed from pulse leading edge (trailing edge) to trailing edge (leading edge) within the gate time. The count value is cleared at every gate time.

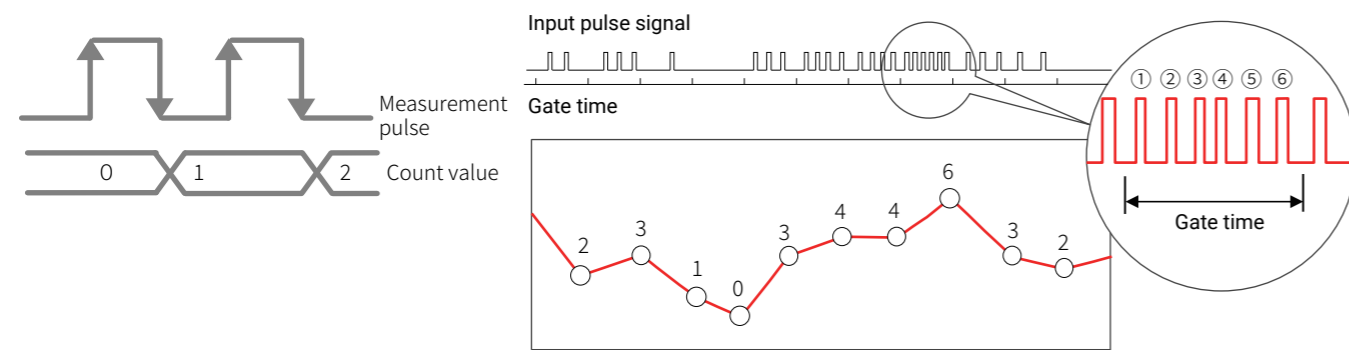

The number of pulse signals input within the gate time is counted and recorded.
 • Maximum integration: Up to 40,000 counts can be counted.
 (Minimum pulse width: 2.5μs)

Pulse Integration Mode

Integrates the number of pulses when the pulse is confirmed from leading edge (trailing edge) to trailing edge (leading edge) of the pulse.

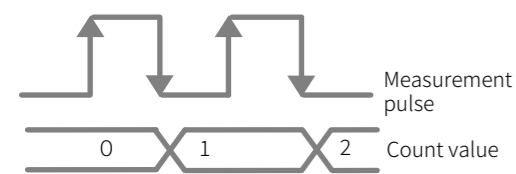

Count value reset operations

- OFF** : Count value is stopped at the range upper limit.
- Start** : When recording starts, the count value is reset and then stopped at the range upper limit.
- Over** : When the count value reaches the upper limit of the range, the count value is reset and measurement starts again from 0.
- Start & Over** : The count value is reset when recording starts. When the count value reaches the upper limit of the range, the count value is reset and measurement starts again from 0.



16ch Logic Module RA30-105

One unit of this input module can input 16 channels of logic signals and when 9 modules are installed in the main unit, 144 channels of logic signals can be measured. Detects and records high and low voltage (0 to 24V) or open and closed contacts. Furthermore, by connecting probes, it is possible to measure high and low AC and DC voltages up to 250V and power line variations (100V and 200V).

<p>Single cable/adaptor</p>	<p>Floating voltage probe 1539S+ 8ch logic cable (round type convertor connector) RA30-503</p>	<p>Voltage conversion probes for recording voltage increases and decreases 1540S/1543S+ 8ch logic cable (round type convertor connector) RA30-503</p>
<p>Function</p> <p>Records high and low voltage (0 to 24V) or open and closed contacts.</p>	<p>High and low AC/DC voltages of up to 250V can be measured.</p>	<p>Power line fluctuations (100V, 200V) can be measured.</p>

High-speed, high-definition recording

High-speed (100mm/s) and high-definition (80dots/mm at 25mm/s) recording is possible. The maximum number of signals that can be recorded simultaneously is 48.

In addition to signals, the recording name, measurement start time, trigger mark, recording speed, etc., can be printed. You can freely change the number of graphs to record, the width of each graph (2.5mm to 215mm), and the space between graphs. In addition, the position and amplitude of the event signal can be changed every 8 channels.

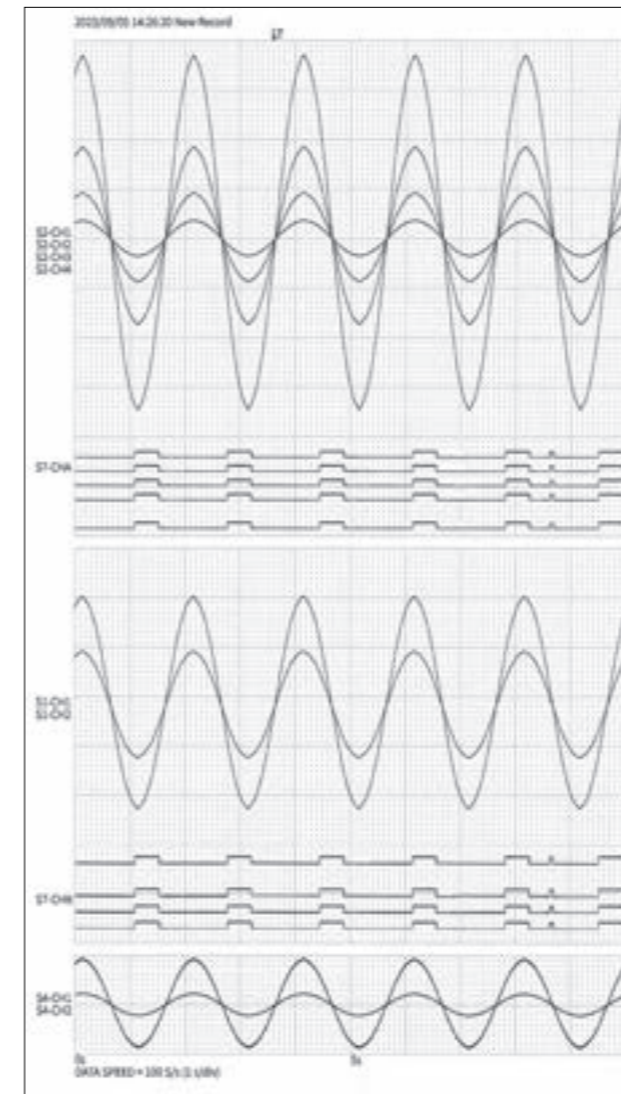

Auto scale

The scale can be printed after recording.

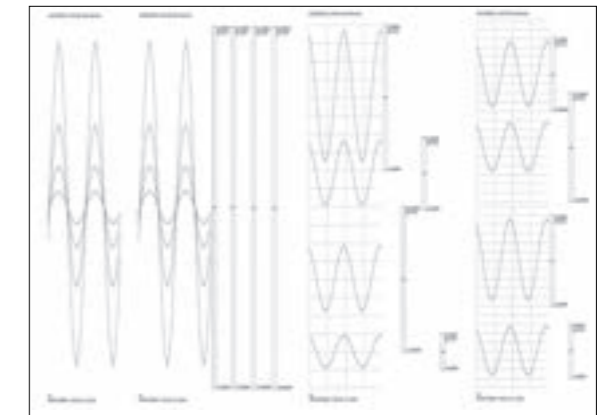

Recording division

Records can be divided from 1 to 18. Recording width can be adjusted from 215mm to 2.5mm.

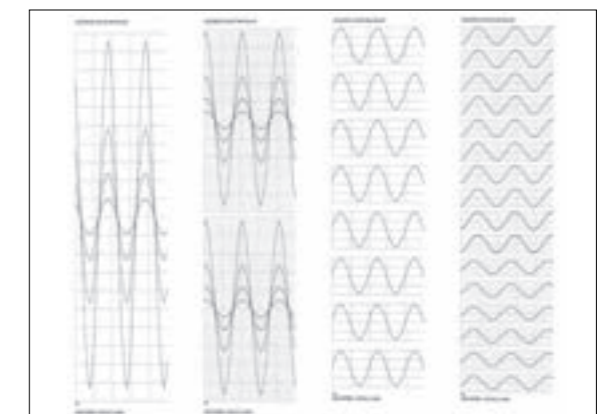

Headers / Annotations / Footers

When recording waveforms to the printer, an arbitrary character string can be printed before (header), during (annotation), and after (footer) the waveform recording.

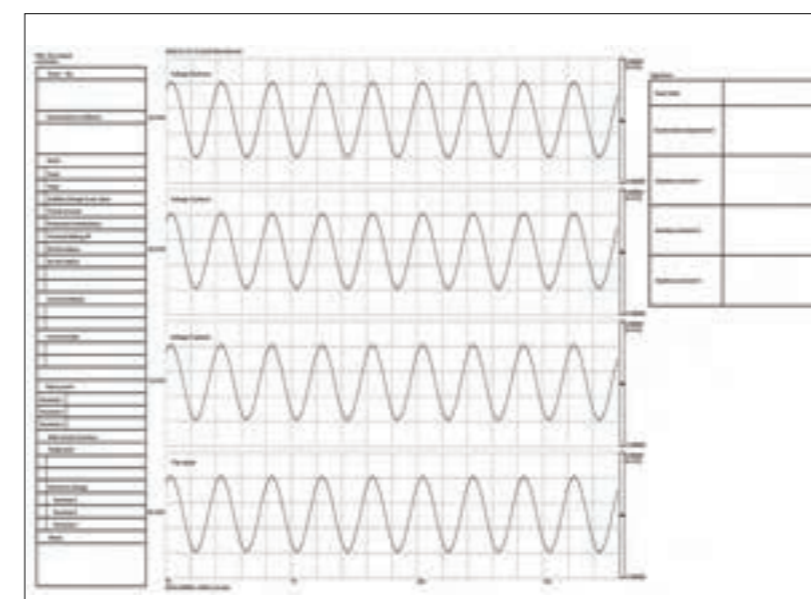

Input Module and Peripheral Option Selection Guide

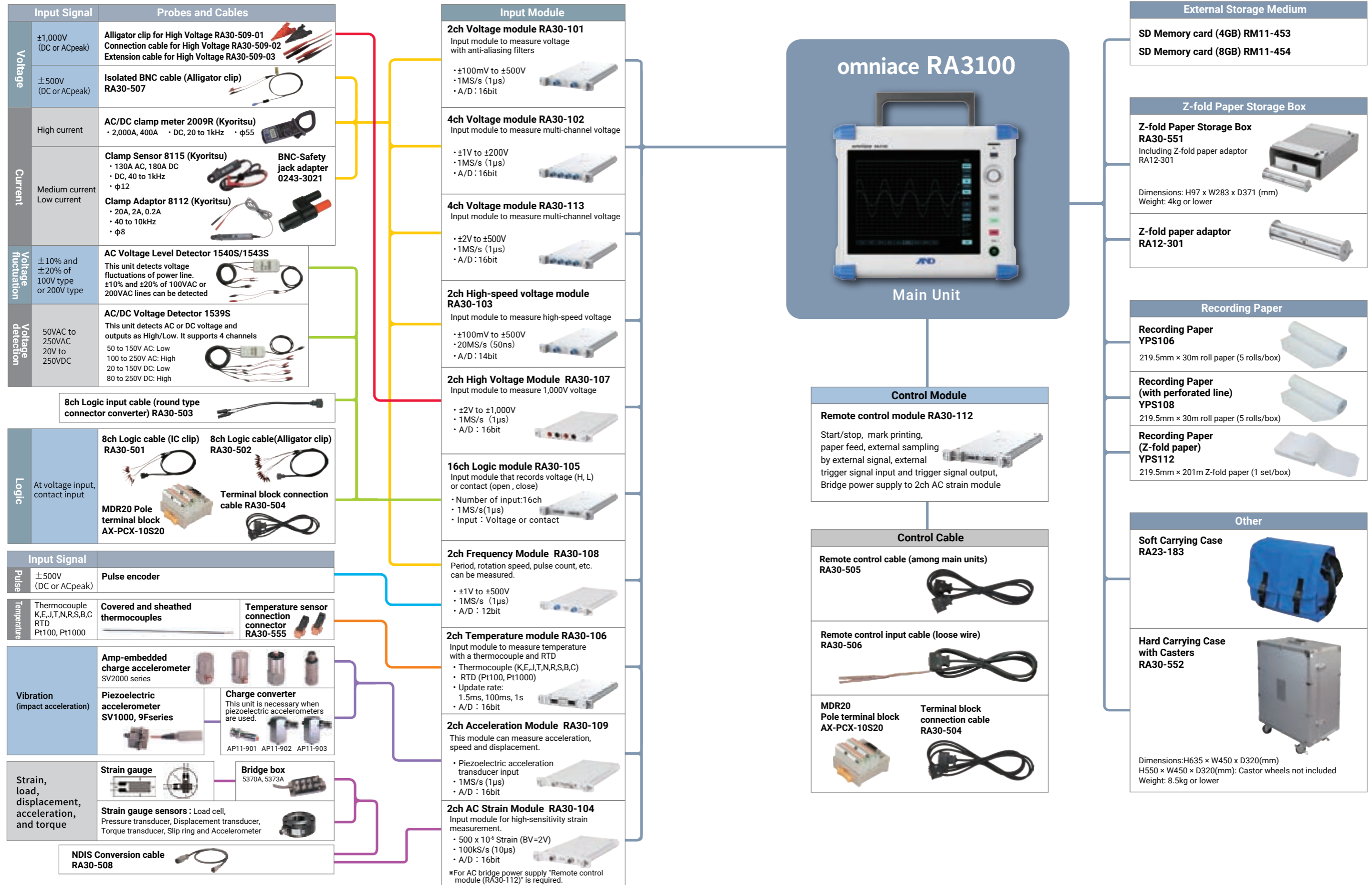

Basic Specifications

Specifications		
Recording Function	Memory Recording	High speed event recording to memory
	SSD Recording	Recording of the input signal to the internal SSD
	Printer Recording	Thermal printing using a thermal head
Channel	Module Slot	9 slots
	Analog Measurement	Max 36 channels (when 9 pcs 4-channel voltage modules are installed)
	Logic Measurement	Max 144 channels (when 9 pcs 16-channel logic modules are installed)
Sampling Speed	Memory Recording	20MS/s(50ns) to 10S/min
	SSD Recording	1MS/s(1µs) to 10S/min
	Printer Recording	1KS/s(100mm/s) to 10S/min(1mm/min)
Memory Capacity	4GB(2G points/ch)	
Storage Device		Solid State Drive (SSD) 256GB
		SD card (supporting SD / SDHC / SDXC) for data storage after recording.
		USB memory using a USB port, for data storage after recording.
Printer	Printing Method	Thermal printing using a thermal head
	Paper Width	219.5mm
	Effective Recording Width	Maximum 215mm
Trigger	Chart Speed	100mm/s to 1mm/min
	Uses	Trigger for starting record operations (Start Trigger), trigger for memory recording (Memory Trigger).
	Start Trigger	Trigger to start recording operation (selected by manual trigger, external trigger, or measuring channel (arbitrary 1ch))
	Memory Trigger	Trigger to start memory recording (selected by manual trigger, external trigger, or measuring channel (arbitrary 1ch))
	Trigger Source	Input signal (analog/logic), manual trigger, external trigger
	Trigger type	Level trigger, window trigger (memory recording trigger), bit pattern trigger
	Trigger Mode	Set AND/OR for the measuring channel.
	Pre-trigger	0 to 99% (1% step)
	Trigger Mark	The trigger point is indicated with a "T" mark, and the trigger date and hour/minute/second are printed.
	Trigger Filter	Filter duration: 0 to 100 seconds
External Trigger Input		External signal input (Active Low, High level: 2.1V to 5.0V, Low level: 0V to 0.5V, Pulse width: at High-speed response: 1µs or higher at high level, 1µs or higher at low level / at Normal response: 1ms or higher at high level, 1ms or higher at low level / at Low response: 10ms or higher at high level, 10ms or higher at low level)
	Trigger Output	Output signal when trigger conditions are met (Active Low, H: 3.8V or higher, L: 0.5V or less, Pulse width: 1µs at high speed response, 1ms at normal response, 10ms at low-speed response)
	Y-T Waveform Monitor	Display amplitude waveform of measuring signal during time changes.
Monitor	X-Y Waveform Monitor	Input signal 1 is plotted in the X axis and input signal 2 is plotted in the Y axis to display correlation of those signals.
	FFT Analysis Monitor	FFT analysis of the measuring signals of any two channels is performed, and the analysis results are displayed in the frequency axis.
Display		12.1-inch XGA TFT color LCD (1024 x 768 pixels) with capacitive touch panel
Operation Section	Operation Panel Key	POWER ... Power ON/OFF START ... Start of measurement STOP ... End of measurement TRIG ... Manual trigger PRINT ... Start of Printer Recording/Screen Copy
	Rotary Knob	Change of the measuring range, waveform position, etc.
	LAN	1000BASE-T (1Gbps) ... For control by communication command
Interface	COM	RS-232C ... For control by communication command
	USB	Ver. 3.0 2 port ... For storage devices (USB memory)
	SD Card	SD standard (SD/SDHC/SDXC supported)
Video Output	DVI-D ... Digital output for external display	
Compliance Standards	Safety	EN 61010-1, EN 61010-2-30 Overvoltage category (installation category) II Measurement category: Depends on the specifications of each input module.
	EMC	EN61326-1 Class A
Operating Environment	Temperature	0 to 40°C
Humidity	35 to 85 %RH (without condensation)	
Storage Environment	Temperature	-20 to 60°C
Humidity	20 to 85%RH (without condensation)	
Vibration Resistance	Random Vibration Durability Test	Frequency: 5 to 500Hz, Acceleration: 6.5m/s ² on X-axis and Y-axis, 10.2m/s ² on Z-axis
	Sine Wave Vibration Durability Test	Frequency: 10 to 55Hz, Acceleration: 20.0m/s ² , 20 cycles for each of the three axes
Backup Battery Life (for Clock Backup)		Approx. 10 years (at the surrounding temperature is 23 °C)
Power Consumption		Power-supply voltage: 100 to 240V AC, frequency 50/60Hz
		Power Consumption: 300VA or less (under the maximum load conditions), 80VA when recording is stopped, 5VA during stand-by
Dimensions		394(W)× 334(H)× 199(D)mm *excluding projections
Weight		9.5kg or less (main body only),

Recording Function Specifications	
Function	After data is recorded to the internal memory at the set sampling rate, the data is automatically saved to the SSD.
Memory Capacity	4GB (2G points/ch)
Data Type	Normal data, Can be saved to a CSV file (trigger criteria 1 to 100%)
Memory Division	1 to 200 Div. (The maximum value changes depending on the channel used and recording length)
Number of data	2,000 to 2G point/ch (1-2.5 step : The maximum value changes depending on the channels and division number used)
Sampling Speed	20MS/s (50ns) to 10S/min, Max. 18ch for 20MS/s when simultaneous measurement
Maximum Recording time	100days
Recording Operation	by START/STOP button for Time recording, Interval recording, and START trigger recording
Function	The measurement data of the input signal is directly recorded to the internal SSD.
Data Logging Capacity	Internal SSD (256GB)
Data type	Normal data and peak data selectable
Sampling Speed	1MS/s (1µs) to 10S/min, Max. 500k/s in case of peak data
External Synchronization Sampling	Synchronous clock: 250kHz or less *Recording by external synchronization can be either SSD recording or printer recording (Pen Record recording).
Maximum Recording Time	100days
Recording Operation	by START/STOP button for Time recording, Interval recording, START trigger recording, window recording
Window Recording	The data is recorded in the ring buffer area (max. 2G point/ch) specified as the window recording time. When the data is exceeded the data area, overwrite from the top the data area and record all data up to the end of measurement. SSD recording can not be used with memory recording and printer recording at the same time. The data format is normal data.
Function	Outputs the input signal directly to the printer.
Paper Width	219.5mm
Effective Recording Width	Maximum 215mm
Recording Operation	by START/STOP button for Time recording, Interval recording, START trigger recording : Waveform recording on the chart paper while saving the data to the SSD. Playback and copy is possible after recording. by PRINT button(Pen-Recording): Direct waveform recording to chart paper without saving any data. Chart speed and measuring range can be changed during recording.
Number of Recording Channels	Max. 48 channels per sheet, Measuring channels can be divided in 3 sheets.
Data Type	Peak data
Chart Speed	100mm/s (1KS/s) to 1mm/min (10S/min), User Default Setting enabled. Max. 50mm/s (500Hz) at external synchronization *Recording by external synchronization can be either SSD recording or printer recording (Pen Record recording).
Printing Density	Amplitude axis : 8dots/mm Time axis : 80dots/mm (at 20mm/s), 40dots/mm (at 50mm/s), 20dots/mm (at 100mm/s) 40dots/mm (at external synchronization)

Monitor Specifications (on recording and replay)	
Recording Function	Displays during memory recording, SSD recording, and printer recording
Supported Data Type	Normal data, Peak data
Number of Sheets (Screen)	Max. 48 channels per sheet (screen), Measuring channels can be divided in 3 sheets (screen).
Number of Graphs	1 to 18 (The height of each graph on the recording paper can be changed in increments of 2.5mm.)
Grid Count	Vertical : 20div., Horizontal: 20div. (when 1 graph is displayed on screen)
Time Axis Data Count	100data/div
Display Function	Numeric display, Signal Name, Amplitude Axis Scale, Recording Time, Trigger Mark, Cursor, Thumbnail
Display Width	The signal of each channel is displayed at an arbitrary width (Set by % as the full display graph width is 100%)
Display Position	Display the signal of each channel at any position (Set by % as the full display graph width is 100%)
Scale Setting	Set the upper limit/lower limit values as input values or physical conversion values for each display width.
Logic Waveform Display	16ch logic waveform display position movable
Recording Function	Displays during SSD recording
Supported Data Type	Normal data
Sampling Rate	1KS/s or less
Display format	1 screen (up to 4 concurrent waveforms), 4 screens (1 waveform per graph)
Grid Count	Vertical : 20div., Horizontal : 20div.
Display Function	Draw X-Y waveform with dots or lines in X-axis/Y-axis scale, pen up/down setting available.
Scale Setting	Set the max/min scale values as input values or physical conversion values for each graph.
Locas	ON/OFF of locas enabled (pen up & down)
Printing	Print the plotted X-Y waveform with the printer
Recording Function	Display during SSD recording
Supported Data Type	Normal data
Sampling Points	1,000, 2,000, 5,000, or 10,000points
Sampling Speed	1MS/s or less
Max Analysis Frequency	1/2 times of the sampling frequency
Display format	1 screen, 2 screens.
Function	Time axis waveform, Linear spectrum, RMS spectrum, Power spectrum, Power spectrum density, 1/1 octave analysis, 1/3 octave analysis, Cross power spectrum, Transfer function, Coherence
Window Function	Hanning, Hamming, Rectangular
Average Processing	Time axis simple addition average, Frequency axis simple addition average, Frequency axis exponentially weighted average, Frequency axis peak hold or off
Number of Averaging	1 to 10
X-axis Scale	Time, Linear Frequency, Log Frequency, 1/1 Octave, 1/3 Octave
Y-axis Scale	Real value area, Imaginary number area, Amplitude, Logarithmic amplitude, Phase Auto scale or manual scale in accordance with the analysis results
Peak Value Display	Extract the local maximum value or a maximum value of 10 points from the analysis result.

Other Specifications		
Recording Mode	There are nine selectable measurement modes. Normal recording/Start time/START trigger/Interval time (N times)/Start time + START trigger/Start time + Interval time (N times)/START trigger + Interval time (N times)/Start time + Interval time (N times)/Window recording	
Playback Processing	Scaling	The display position can be changed with pinch-in, pinch-out scaling, zooming, and swiping.
	Cursor	Y-T : Measured value at the cursor position Time display between cursors, Max/Min value/Average value FFT : Cursor position frequency and pulse amplitude
	Back Scrolling	Measured data can be monitored while recording by pressing the [PAUSE] button.
Printer Section	System Annotations	Measurement start time, Recording name, Trigger condition (Trigger point, Trigger date, Trigger time) Sampling speed, Chart speed, Time axis, etc. are printed at the same time as waveform recording
	Mark Print	Printing marks (date/time) on the chart paper or the data on SSD
	Header, Footer, and Page Annotations	Any character can be printed before, during, or after the waveform area during printing (Up to 60 characters horizontally and 86 lines vertically)
	Screen Copy	Print screen image on chart paper
Screen Image Saving	Save screenshots in PNG format (color) on the main unit or on a storage medium	
Save/Readout of Settings	Save settings (input and main unit setting conditions) on SSD Measuring conditions saved in the SSD can be read out.	
Keylock Function	· Lock operation panel keys · Lock the touch panel	
Monitor Brightness	Adjustable	
Physical Value Conversion	Physical conversion of input signals, Change of full scale on display, Registration of units.	
Language	Japanese, English, Chinese (simplified, combined), Korean	

Remote Control Module Specifications

Remote Control Module RA30-112 Specifications	
Input Connector	half-pitch 20-pin connector
Output Connector	half-pitch 14-pin connector
External Input	Function : Control by external signal.
Control Signal	START/STOP, MARK, FEED, PRINT, TRIG
Input Level	High level : 2.1V to 5.0V, Low level : 0V to 0.5V (active low)
Response Speed	Select from High-speed/Normal/Low-speed
Effective Pulse Width	High-speed response : 1µs or higher during high interval, 1µs or higher during low interval Normal response : High interval 1ms or higher, Low interval 1ms or higher Low-speed response : 10ms or higher during high, 10ms or higher during low-speed response
Max. allowable Input Voltage	30V
External Output	Function : Control signals can be externally output
Control Signal	START/STOP, MARK, FEED, PRINT, TRIG, EXT1/EXT2
Output Level	High level: 3.8V to 5.0V, Low level: 0V to 0.5V (active low)
Output Pulse Width	START/STOP, FEED, PRINT : Active output during operation TRIG, MARK : High-speed response: 1µs/Normal response : 1ms/ Low-speed response: 10ms
External Sampling Input (EXT.SMPL IN)	Synchronization via external clock signal is possible (simultaneous SSD recording and printer recording are not possible.)
Input Level	High level : 2.1V to 5.0V, Low level : 0V to 0.5V
Effective Pulse Width	High-speed (SSD Recording) : 2µs or higher/Low-speed (Printer Recording) : 1ms or higher
Maximum Input Frequency	High-speed (SSD Recording) : 250kHz/Low-speed (printer recording) : 500Hz, 0.1mm/pulse
External Sampling Output (EXT.SMPL OUT)	Function: Synchronization clock signal can be output externally
Output Level	High level : 3.8V to 5.0V, Low level : 0V to 0.5V (active low)
Synchronization Signal for AC Strain Input/Output	Function : Synchronization signal generator for using AC strain
Carrier Wave	0V to 5V, square wave, 5kHz
Synchronization	Synchronization possible with other RA3000 product including RA30-112
Reference Clock for Calibration	Function : Square wave signal output for operation check of voltage input module
Output Level	0V to 5V (±1%)
Output Frequency	1kHz (±1%)
Duty Ratio	50% (±5%)
Withstand voltage	AC300V, 1 minute (between input/output and main chassis)
Maximum Rated Voltage to Ground	AC, DC42V
Dimensions	Approx. 140 (input-side W) x 223(D) x 20(H) mm
Weight	Approx. 250g
Compliance Standards	Safety : EN61010-1 EMC : EN61326-1, class A

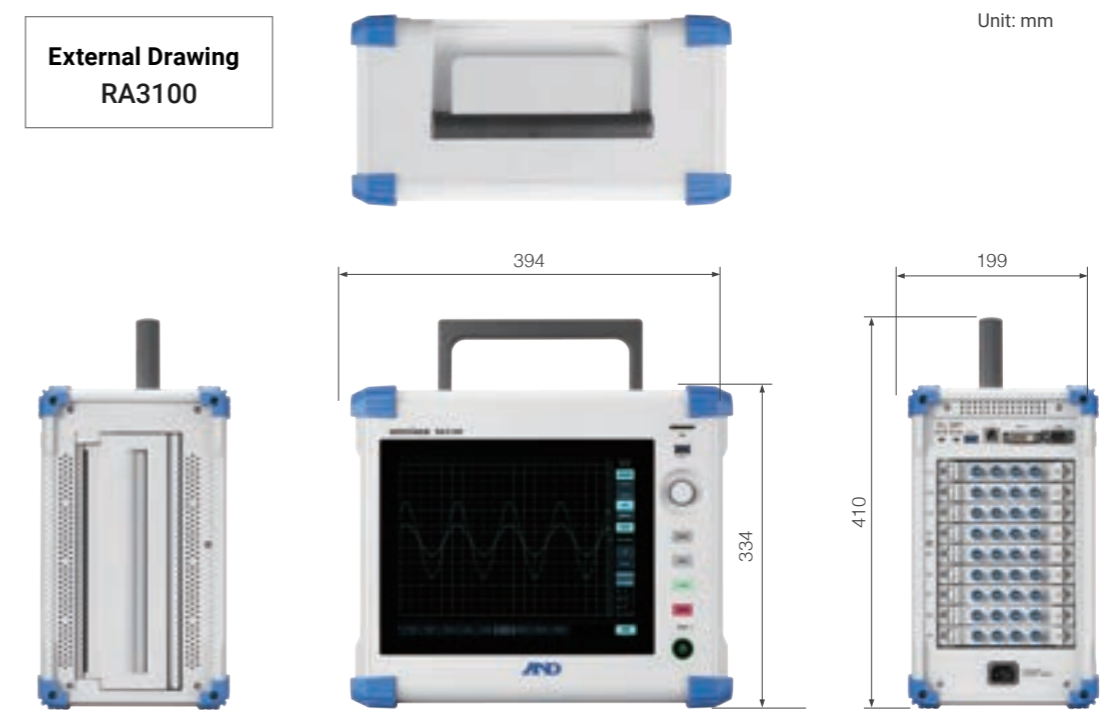

Input Module Specifications

2ch Voltage Module RA30-101	
Input Channels	2ch
Input Connector	Isolated BNC connector
Input Type	Isolated unbalanced input (Isolation between each channel, between each channel and main chassis)
Input Coupling	AC, DC, and GND coupling
Input Impedance	1MΩ
Measurement Range (RANGE)	±100, 200, 500mV, 1, 2, 5, 10, 20, 50, 100, 200, 500V
Measurement Accuracy	±0.3% of range (23°C±5°C, DC coupling, LPF 3Hz, after zero offset)
Temperature Coefficient	± (400ppm of range)/°C
Frequency Response	DC coupling : DC to 100kHz(-3dB to +1dB)(with LPF, AAF OFF) AC coupling : 0.3Hz to 100kHz(-3dB to +1dB)(with LPF, AAF OFF) Cutoff frequency : 3Hz, 30Hz, 300Hz, 3kHz, OFF (-1.6dB±1dB) Characteristics : 2 pole Bessel type
Low-pass Filter(LPF)	Cutoff frequency : 20, 40, 80, 200, 400, 800, 2k, 4k, 8k, 20k, 40kHz, OFF
Anti-aliasing Filter(AAF)	Attenuation : -66dB or less at 1.5 times of cutoff frequency
A/D Converter	A/D resolution : 16bit Sampling rate : 1MS/s (max)
Allowable Input Voltage	±500V peak
Maximum Rated Voltage To Ground	300V AC/DC CATII(between channels, between input terminals and chassis)
Withstand Voltage	3kV AC, 1 minute(between input terminal and main chassis, between each channel)
Dimensions	Approx. 140 (input-side W) x 223(D) x 20(H) mm
Weight	Approx. 300g
Compliance Standards	Safety : EN61010-1, EN61010-2-30 EMC : EN61326-1, class A

4ch Voltage Module RA30-102, RA30-113	
Input Channels	4ch
Input Connector	Isolated BNC connector
Input Type	Isolated unbalanced input (Isolation between each channel, between each channel and the main chassis)
Input Coupling	DC and GND coupling
Input Impedance	1MΩ or higher
Measurement Range (RANGE)	RA30-102 : 1, 2, 5, 10, 20, 50, 100, 200V RA30-113 : 2, 5, 10, 20, 50, 100, 200, 500V
Measurement Accuracy	±0.2% of RANGE (23°C ±5°C, DC coupling, LPF 3Hz, after zero offset)
Temperature Coefficient	±(400ppm of range)/°C
Frequency Response	DC coupling : DC to 100kHz(-3dB to +1dB)(with LPF OFF) Cutoff frequency : 3Hz, 30Hz, 300Hz, 3kHz, OFF (-1.6dB±1dB) Characteristics : 2 pole Bessel type
Low-pass Filter(LPF)	Cutoff frequency : 20, 40, 80, 200, 400, 800, 2k, 4k, 8k, 20k, 40kHz, OFF
A/D Converter	A/D resolution : 16bit Sampling rate : 1MS/s (max)
Allowable Input Voltage	RA30-102 : ±200V peak / RA30-113 : ±500V peak
Maximum Rated Voltage to Ground	300V AC/DC CATII(between channels, between input terminals and chassis)
Withstand Voltage	3kV AC, 1 minute(between channels or between input terminals and chassis)
Dimensions	Approx. 140 (input-side W) x 223(D) x 20(H) mm
Weight	Approx. 320g
Compliance Standards	Safety : EN61010-1, EN61010-2-30 EMC : EN61326-1, class A

2ch High Speed Voltage Module RA30-103	
Input Channels	2ch
Input Connector	Isolated BNC connector
Input Type	Isolated unbalanced input (Isolation between channels, between each channel and chassis)
Input Coupling	AC, DC, and GND coupling
Input Impedance	1MΩ or higher
Measurement Range (RANGE)	±100, 200, 500mV, 1, 2, 5, 10, 20, 50, 100, 200, 500V
Measurement Accuracy	± 0.5% of RANGE (23°C ±5°C, DC coupling, LPF 5Hz, after zero offset)
Temperature Coefficient	± (500ppm of range)/°C
Frequency Characteristics	DC coupling : DC to 5MHz(-3dB to +1dB) (with LPF OFF) AC coupling : 6Hz to 5MHz(-3dB to +1dB)(with LPF OFF)
Low-pass Filter(LPF)	Cutoff frequency : 5Hz, 50kHz, 500kHz, OFF (-3dB±1dB)
A/D Converter	A/D resolution : 14bit Sampling rate : 20MS/s (max)
Common Mode Rejection Ratio	80dB or higher (50/60Hz)
Allowable Input Voltage	500V peak
Maximum Rated Voltage to Ground	300V AC/DC CATII(between channels, between input terminals and chassis)
Withstand Voltage	3kV AC, 1 minute(between channels, between input terminals and chassis)
Dimensions	Approx. 140 (input-side W) x 223(D) x 20(H) mm
Weight	Approx. 300g
Compliance Standards	Safety : EN61010-1, EN61010-2-30 EMC : EN61326-1, class A

2ch High Voltage Module RA30-107	
Input Channels	2ch
Input Connector	Safety banana socket
Input Type	Isolated unbalanced input (Isolation between each channel, between each channel and main chassis)
Input Coupling	AC, DC, and GND coupling
Input Impedance	4MΩ
Measurement mode	Voltage measurement mode / RMS measurement mode
Response time (when RMS measurement mode)	High speed : 0.1s (within ±10%), Medium speed : 0.25s (within ±10%), Low speed : 1s (within ±10%) *1 All of the above are leading edge 0% → 90% of RANGE, trailing edge 100% → 10% of RANGE
Measurement Range (RANGE)	± 2, 5, 10, 20, 50, 100, 200, 500, 1,000V
Voltage measurement mode:	±0.3% of range (DC coupling, LPF 3Hz)(23°C ±5°C, DC coupling, LPF 3Hz, after zero offset)
When DC coupled	±0.3% of range (DC coupling, LPF 3Hz)(23°C ±5°C, DC coupling, LPF 3Hz, after zero offset)
When AC coupled (Sine wave input)	For low speed response : ±0.5% of RANGE (10Hz to 1kHz input), ±1.5% of RANGE (1kHz to 10kHz input) For medium speed response : ±0.5% of RANGE (40Hz to 1kHz input), ±1.5% of RANGE (1kHz to 10kHz input) For high speed response : ±0.5% of RANGE (100Hz to 1kHz input), ±1.5% of RANGE (1kHz to 10kHz input) * All of the above are at 23°C ±5°C, after zero cancellation.
Temperature Coefficient	± (300ppm of range)/°C
Frequency Response	DC coupling : DC to 100kHz (-3dB to +1dB) (with voltage measurement mode, LPF OFF) AC coupling : 0.3Hz to 100kHz (-3dB to +1dB) (with voltage measurement mode : LPF OFF)
Low-pass Filter(LPF)	Cutoff frequency : 3Hz, 30Hz, 300Hz, 3kHz, OFF (-1.6dB±1dB) Characteristics : 2 pole Bessel type

A/D Converter	A/D resolution : 16bit Sampling rate : 1MS/s (max)
Allowable Input Voltage	±1,000V peak
Maximum Rated Voltage To Ground	1,000V AC/DC CATII (between channels, between input terminals and chassis) 600V AC/DC CATIII (between channels, between input terminals and chassis)
Withstand Voltage	3kV AC, 1 minute(between channels or between input terminals and chassis)
Dimensions	Approx. 140 (input-side W) x 223(D) x 20(H) mm
Weight	Approx. 300g
Compliance Standards	Safety : EN61010-1, EN61010-2-30 EMC : EN61326-1, class A

16ch Logic Module RA30-105	
Input Channels	16ch
I/O Connector	8ch x 2 ports
Input Type	Single input, common input (non-isolated), isolated between input signal and main chassis
Voltage Detection	Input range : 0 to 24V Threshold value : 1.4V (±0.4V)/2.5V (±0.5V)/4V (±0.6V) (selectable from 3 levels) Input Impedance : 1MΩ ±1%
Contact Detection	Threshold (selectable from below 3 levels) Close (High level) : 250 Ω or less/Open (Low level) : 2kΩ or more Close (High level) : 1.5kΩ or less/Open (Low level) : 5kΩ or more Close (High level) : 3kΩ or less/Open (Low level) : 9kΩ or more Load current : 0.5mA (typ.) at load resistance 0 to 18kΩ
Responsive Pulse	2μs or higher
Allowable Input Voltage	30V DC
Maximum Rated Voltage to Ground	42V AC/DC
Withstand Voltage	300V AC, 1 minute(between channels, between input terminals and chassis)
Power Output for Options	For connecting our probe
Dimensions	Approx. 140 (input-side W) x 223(D) x 20(H) mm
Weight	Approx. 250g
Compliance Standards	Safety : EN61010-1, EN61010-2-30 EMC : EN61326-1, class A

2ch Temperature Module RA30-106	
Input Channels	2ch
Input Connector	Removable socket (front panel) Temperature sensor connector coupling wire: 0.2 SQ to 1.5 SQ (AWG24 to AWG16)
Input Type	Isolated unbalanced input (Isolation between channels, between each channel and chassis)
Input Impedance	5MΩ or higher
Adaptive Sensor	Thermocouple : K, E, J, T, N, R, S, B, C (JIS C1602:2015) Resistance temperature detector (RTD) : Pt100, Pt1000 (JIS C1604:2013)

Cold Junction Compensation					
Internal/external switching type					
Internal Cold Junction Compensation Temp.					
±1°C (23°C ±5°C), ±1.5°C (overall temperature range)					
Disconnection Detection					
ON/OFF switchable					
Thermocouple	Measurement Range/Accuracy	T/C Type	Measur-ment Range (RANGE)	Measuring range (°C)	Measurement Accuracy
		K	200°C	-200 to 200	-200 to 0°C±(0.1% of RANGE + 2°C)
			600°C	-200 to 600	0 to 1370°C±(0.1% of RANGE + 1°C)
			1370°C	-200 to 1370	
		E	200°C	-200 to 200	-200 to 0°C±(0.1% of RANGE + 2°C)
			600°C	-200 to 600	0 to 1000°C±(0.1% of RANGE + 1°C)
			1000°C	-200 to 1000	
		J	200°C	-200 to 200	-200 to 0°C±(0.1% of RANGE + 2°C)
			400°C	-200 to 400	0 to 1100°C±(0.1% of RANGE + 1°C)
			1100°C	-200 to 1100	
		T	100°C	-100 to 100	-200 to 0°C±(0.1% of RANGE + 2°C)
			200°C	-200 to 200	0 to 400°C±(0.1% of RANGE + 1°C)
			400°C	-200 to 400	
		N	200°C	-200 to 200	-200 to 0°C±(0.1% of RANGE + 2°C)
			600°C	-200 to 600	0 to 1300°C±(0.1% of RANGE + 1°C)
			1300°C	-200 to 1300	
		R	200°C	0 to 200	0 to 400°C±(0.1% of RANGE + 3.5°C)
			1000°C	0 to 1000	400 to 1760°C±(0.1% of RANGE + 3°C)
			1760°C	0 to 1760	
		S	1000°C	0 to 1000	0 to 400°C±(0.1% of RANGE + 3.5°C)
			1700°C	0 to 1700	400 to 1760°C±(0.1% of RANGE + 3°C)
			600°C	400 to 600	
		B	1000°C	400 to 1000	400 to 1800°C±(0.1% of RANGE + 3°C)
			1800°C	400 to 1800	
600°C	0 to 600				
C	1200°C	0 to 1200	0 to 400°C±(0.1% of RANGE + 3.5°C)		
	2300°C	0 to 2300	400 to 2300°C±(0.1% of RANGE + 3°C)		

Temperature Coefficient	(Measurement Accuracy × 0.1)/°C				
Measurement Type	3-wire type				
Measurement Current	0.5mA, 1mA switchable (at Pt100), fixed at 0.1mA (at Pt1000)				
Resistance Temperature Detector (RTD)	Measurement Range	Type	Measur-ment Range (RANGE)	Measuring range (°C)	Measurement Accuracy
		Pt100	200°C	-200 to 200	-200 to 850°C
			400°C	-200 to 400	±(0.1% of RANGE ±0.5°C)
			850°C	-200 to 850	
		Pt1000	200°C	-200 to 200	
			400°C	-200 to 400	
850°C	-200 to 850				
Temperature Coefficient	(Measurement Accuracy × 0.1)/°C				

A/D Converter	A/D resolution : 16bit Data update rates : high speed (1.5ms), normal speed (100ms), low speed (1s)
Common Mode Rejection Ratio	100dB (Data update: normal speed, low speed), 80dB (Data update: High speed) at 50/60Hz, Signal source resistance 1kΩ
Allowable Input Voltage	30V peak
Maximum Rated Voltage To Earth	300V AC/DC(between channels, between input terminals and chassis)
Withstand Voltage	3kV AC, 1 minute(between channels, between input terminals and chassis)
Dimensions	Approx. 140 (input-side W) x 223(D) x 20(H) mm
Weight	Approx. 300g
Compliance Standards	Safety : EN61010-1, EN61010-2-30 EMC : EN61326-1, class A
Accessories	Temperature sensor connection connector(RA30-555) 2pcs/sets

2ch Frequency Module RA30-108	
Input Channels	2ch
Input Connector	Isolated BNC connector
Input Type	Isolated unbalanced input (Isolation between each channel, between each channel and main chassis)
Input Coupling	AC, DC, and GND coupling
Input Impedance	1MΩ
Measurement Range (RANGE)	Range for the input signal: 1, 2, 5, 10, 20, 50, 100, 200, 500V
Measurement Probability	±3% of RANGE (23°C±5°C, DC coupling, LPF 300Hz)
Measurement Signal	4 signals Signal 1 : 1ch measurement mode, Signal 3 : 1ch input signal Signal 2 : 2ch measurement mode, Signal 4 : 2ch input signal
Response Speed	Variable from -200V to +200V
Voltage Range	1 to 10% of RANGE (1% steps)
Hysteresis	Period, frequency, rotation speed, pulse width, duty ratio, power supply frequency, frequency deviation, pulse count, pulse integration Available measurement range : 5us to 100s Measurement range (RANGE) : 1, 2, 5, 10, 20, 50, 100, 200, 500ms, 1, 2, 5, 10, 20, 50, 100s
Period Mode	Measurement probability : ±0.5%rdg (1ms RANGE), ±0.3%rdg (2ms RANGE), ±0.1%rdg (5ms RANGE), ±0.05%rdg (10ms to 100s RANGE) Pulse averaging process : 2 to 4,096 Smoothing process : OFF, 2 to 100
	Available measurement range : 0 to 200kHz Measurement range (RANGE) : 2, 5, 10, 20, 50, 100, 200, 500Hz, 1, 2, 5, 10, 20, 50, 100, 200kHz
Frequency mode	Measurement probability : ±0.5%rdg (200kHz RANGE), ±0.3%rdg (100kHz RANGE), ±0.1%rdg (50kHz RANGE), ±0.05%rdg (2Hz to 20kHz RANGE) Pulse averaging process : 2 to 4,096 Smoothing process : OFF, 2 to 100
	Available measurement range : 0 to 1,000krpm Measurement range (RANGE) : 10, 20, 50, 100, 200, 500, 1k, 2k, 5k, 10k, 20k, 50k, 100k, 200k, 500k, 1,000krpm Measurement probability : ±0.05%rdg Pulse averaging process : 2 to 4,096 Pulse/Rev : 1 to 100 Smoothing process : OFF, 2 to 100
Rotation speed mode	Available measurement range : 2.5us to 100s (min. pulse width: 2.5us) Measurement range (RANGE) : 1, 2, 5, 10, 20, 50, 100, 200, 500ms, 1, 2, 5, 10, 20, 50, 100s
	Measurement probability : ±0.25%rdg (1ms RANGE), ±0.15%rdg (2ms RANGE), ±0.05%rdg (5ms to 100s RANGE) Pulse polarity : Positive, Negative Pulse averaging process : 2 to 4,096 Smoothing process : OFF, 2 to 100
Pulse width mode	Measurable frequency range: 1Hz to 20Hz : 100% (20Hz) RANGE (min. pulse width 500μs) 10Hz to 200Hz : 100% (200Hz) RANGE (min. pulse width 50us) 100Hz to 2kHz : 100% (2kHz) RANGE (min. pulse width 5us) 1kHz to 20kHz : 100% (20kHz) RANGE (min. pulse width 2.5us) Measurement range (RANGE) : 100% (20Hz), 100% (200Hz), 100% (2kHz), 100% (20kHz)
	Measurement probability : ±0.05% (1Hz) to ±1% (20Hz) of 100% (20Hz) RANGE * ±1% x input frequency / 20Hz * ±0.05% (10Hz) to ±1% (200Hz) of 100% (200Hz) RANGE * ±1% x input frequency / 200Hz * ±0.05% (100Hz) to ±1% (2kHz) of 100% (2kHz) RANGE * ±1% x input frequency / 2 kHz * ±0.25% (1kHz) to ±5% (20kHz) of 100% (20kHz) RANGE * ±5% x input frequency / 20kHz Measurable duty ratio range : 0 to 100% Pulse polarity: Positive, Negative Pulse averaging process : 2 to 4,096 Smoothing process : OFF, 2 to 100

Measurement Mode	Duty ratio mode	Measurement range (RANGE) : 50Hz (30 to 70Hz), 60Hz (40 to 80Hz), 400Hz (360 to 440Hz) Measurement probability : ±0.002%rdg (50Hz RANGE), ±0.003%rdg (60Hz RANGE), ±0.005%rdg (400Hz RANGE) Pulse averaging process : 2 to 4,096 Smoothing process : OFF, 2 to 100
		Available measurement range : 3.3Hz to 19,800Hz Measurement range (RANGE) : ±50% (center frequency range 6.6Hz to 13.2kHz) Measurement probability : ±0.05%rdg Center frequency : 3.3Hz to 19,800Hz Pulse averaging process : 2 to 4,096 Smoothing process : OFF, 2 to 100
Power frequency mode	Range of variation mode	Measurement range (RANGE) : Fixed at 40,000 Measurement probability : ±0.003%rdg Available measurement range : 16.6666mHz to 200kHz (min. pulse width 2.5μs) Gate time : 200, 500ms, 1, 2, 5, 10, 20, 30, 60s Pulse polarity : Positive, Negative
		Measurement range (RANGE) : 50, 100, 200, 500k, 1, 2, 5, 10, 20, 50, 100, 200, 500M, 1, 2G Measurement probability : ±0.002%rdg Available measurement range : 5mHz to 200kHz (min. pulse width 2.5μs) Pulse polarity : Positive, Negative Integration auto-reset : OFF, Start, Over, Start & Over
Pulse count mode	Pulse integration mode	Measurement range (RANGE) : 50, 100, 200, 500k, 1, 2, 5, 10, 20, 50, 100, 200, 500M, 1, 2G Measurement probability : ±0.002%rdg Available measurement range : 5mHz to 200kHz (min. pulse width 2.5μs) Pulse polarity : Positive, Negative Integration auto-reset : OFF, Start, Over, Start & Over
		Measurement range (RANGE) : Fixed at 40,000 Measurement probability : ±0.003%rdg Available measurement range : 16.6666mHz to 200kHz (min. pulse width 2.5μs) Gate time : 200, 500ms, 1, 2, 5, 10, 20, 30, 60s Pulse polarity : Positive, Negative

Measurement Mode	Deceleration Stop Processing Function	If the pulse input is interrupted, the deceleration state is calculated in real time and the measured value is set to 0 or OVER RANGE in steps.
		Pulse/Rev
Measurement Mode	Pulse polarity	Positive: Detects and determines a measured pulse from its leading edge to trailing edge. Negative: Detects and determines a measured pulse from its trailing edge to leading edge.
		Integration auto-reset
Measurement Mode	Pulse averaging process function	Takes the average of the set number of measurement data as the data to be output. Effective for taking out irregularities in the input signal. However, data is not output until the set number of pulses is measured.
		Smoothing process function
Measurement Mode	Low-pass Filter(LPF)	Cutoff frequency : 300Hz, 3kHz, 30kHz, OFF (-1.6dB±1dB) Characteristics : 2 pole Bessel type
		A/D Converter

Allowable Input Voltage	±500V peak
Maximum Rated Voltage To Ground	300V AC/DC CATII (between channels, between input terminals and chassis)
Withstand Voltage	3kV AC, 1 minute(between channels, between input terminals and chassis)
Dimensions	Approx. 140 (input-side W) x 223(D) x 20(H) mm
Weight	Approx. 300g
Compliance Standards	Safety : EN61010-1, EN61010-2-30 EMC : EN61326-1, class A

2ch AC Strain Module RA30-104	
Input Channels	2ch
Input Connector	NDIS4109 Connector (conversion cable sold separately)
Bridge Voltage (BV)	0.5V AC, 2V AC, 5kHz Sine Wave
Applicable Strain Gauge Resistance	120Ω to 350Ω
Gauge Rate	2
Equilibrium adjustment range and adjustment method	Within 10,000 x 10 ⁻⁶ strain, within 2,000pF capacitance
Equilibrium adjustment accuracy	±0.3% of RANGE
Temperature coefficient	±(400ppm of RANGE)/°C
Measurement range (RANGE)	500, 1,000, 2,000, 5,000, 10,000, 20,000 x 10 ⁻⁶ strain (at 2Vrms bridge power) 2,000, 4,000, 8,000, 20,000, 40,000, 80,000 x 10 ⁻⁶ strain (at 0.5Vrms bridge power)
Non-linearity	±0.1% of RANGE
Frequency Characteristics	DC to 2kHz ±10%
Simple Bridge Check	It can detect short-circuits on bridge sides and disconnections of some cables and bridge sides.
Low-Pass Filter (LPF)	Cutoff frequency : 10Hz, 30Hz, 100Hz, 300Hz, OFF (-3dB±1dB) Characteristics : Secondary Butterworths
Internal Calibrator	±1 to 9,999 x

Main Unit & Accessories

Main Unit		
Item	Model	Specifications
Omniace	RA3100	Standard accessories: AC power cable × 1, recording paper × 1, paper holder × 1 pair, input module slot cover plate × 1 set, quick operation guide × 1, instruction manual CD-ROM × 1

Input Module		
Item	Model	Specifications
2ch Voltage Module*1	RA30-101	Sample rate 1MS/s, Input ±100mV to ±500V, A/D resolution 16bit, Anti-aliasing filter
4ch Voltage Module*1	RA30-102	Sample rate 1MS/s, Input ±1V to ±200V, A/D resolution 16bit
2ch High Speed Voltage Module*1	RA30-103	Sample rate 20MS/s, Input ±100mV to ±500V, A/D resolution 14bit
2ch AC Strain Module*3	RA30-104	2ch, Max. strain input 500 × 10 ⁻⁶ strain, AC bridge method, Frequency response DC to 2kHz
16ch Logic Module*5	RA30-105	Input 16ch (voltage or contact)
2ch Temperature Module*4	RA30-106	Data update rate 1.5ms, Thermocouple/RTD, 2 temperature sensor connectors (RA30-555) included
2ch High Voltage Module*2	RA30-107	2ch, max. input ±1,000V, sample rate 1MS/s, RMS conversion
2ch Frequency Module*3	RA30-108	2ch, Pulse input, Input ±500V
2ch Acceleration Module*6	RA30-109	2ch, acceleration transducer (charge output type, voltage output type) input, acceleration, speed, displacement, TEDS compatible
4ch Voltage Module*1	RA30-113	4ch, Sample rate 1MS/s, Input ±2V to ±500V, A/D resolution 16bit

- *1 Use Isolated BNC cable (Alligator clip) RA30-507
 *2 Use Alligator clip for High Voltage (RA30-509-01), Connection cable for High Voltage (RA30-509-02).
 *3 Remote Control Module (RA30-112) is required for 2ch AC Strain Module (RA30-104) to supply AC bridge power. Use NDIS Conversion cable (RA30-508) to connect NDIS connector (NDIS4102).
 *4 A temperature sensor connector RA30-555 is provided to attach the temperature sensor to the 2ch temperature module.
 *5 Use 8ch Logic cable (RA30-501, RA30-502, RA30-503), cable for connecting the terminal block (RA30-504).
 *6 When using Charge converter (AP11-902, AP11-903), use Signal cable (AS30-504).

Control Module		
Item	Model	Specifications
Remote Control Module*7	RA30-112	Remote control, TRIG IN and OUT, and synchronization signal output when AC strain module is used

- *7 Use a remote control module cable (RA30-505, RA30-506) to connect the remote control module to other devices.

Signal Input Related Options		
Item	Model	Specifications
Isolated BNC Cable (Alligator clip)	RA30-507	1.5m length with an Isolated BNC - safety alligator clip (+red,-black), connected to RA30-101, -102, -103, -108,-113
Alligator clip for High Voltage	RA30-509-01	High voltage alligator clips, CAT III 1,000V, 1 red and 1 black per channel
Connection cable for High Voltage	RA30-509-02	High voltage connection cable 2m, CAT III 1,000V, S-banana plug to S-banana plug, 1 red and 1 black per channel
Extension cable for High Voltage	RA30-509-03	High voltage extension cable 2m, CAT III 1,000V, S-banana jack to S-banana plug, 1 red and 1 black per channel
NDIS Conversion cable	RA30-508	Conversion cable to connect NDIS connector (NDIS4102) of bridge box and strain gage type transducers. For 1ch, length 60cm
Signal cable	AS30-503	2m length, Metal BNC to alligator clip (+red,-black), connected to RA30-109
	AS30-504	2m length, Metal BNC to Metal BNC, connect to RA30-109 and AP11-902/903 charge converter
	0311-5175	2m length, Isolated BNC to alligator clip (+red,-black), connected to RA30-101~103,-108,-113
	0311-5200	2m length, Metal BNC to Isolated BNC, connected to RA30-101~103,-108,-113
8ch Logic Cable (IC clip)	RA30-501	1.5m length for logic input, IC terminal clip (8ch), connected to RA30-105
8ch Logic Cable (Alligator clip)	RA30-502	1.5m length for logic input, electrical terminal clip (8ch), connected to RA30-105
8ch Logic Cable (round type connector converter)	RA30-503	30cm length conversion cable for connection to the RA30-105 from the 1539S
Cable for Terminal Block	RA30-504	2m length, connected to the RA30-105 or RA30-112, attach the MDR20 terminal block AX-PCX-10S20
Remote Control Cable (to connect between main units)	RA30-505	2m length, connect the RA30-112 to connect with another RA3100 unit each other
Remote Control Cable (without another connector)	RA30-506	2m length, connect to the RA30-112 to control the RA3100 main unit
Temperature Sensor Connection Connector	RA30-555	Connector attached to the terminal of temperature sensor connected to the RA30-106, 2 pcs/sets
MDR20 Terminal Block for AD4430C	AX-PCX-10S20	Used as terminal block for IN/OUT of RA30-105, RA30-112 signals
BNC Adaptor*8	0243-3021	Isolated BNC connector and Safety terminal plug, When using Clamp Adaptor (8112), AC/DC Clamp Sensor (8115)
Charge Converter (For Piezoelectric Acceleration Transducer)	AP11-901	Gain 1.0mV/pC, Max Input Charge 5,000pC, Compact type
	AP11-902	Gain 1.0mV/pC, Max Input Charge 5,000pC
	AP11-903	Gain 0.1mV/pC, Max Input Charge 50,000pC, For High Sensitivity Transducer

- *8 When 2ch AC Strain Module (RA30-102) is installed in an adjacent slot, BNC Adaptor (0243-3021) cannot be installed for all channels.

Options Related to Current and Voltage Measurement		
Item	Model	Specifications
AC/DC Voltage Detector	1539S	4 inputs, AC/DC voltage detector that detects presence of selected low or high voltages and outputs Hi/Lo logic signal
Voltage Fluctuation Detector	1540S	Detects 100/120V AC voltage sags & surges exceeding selected 10% or 20% of AC peak value and outputs as pulse
	1543S	Detects 220/240V AC voltage sags & surges exceeding selected 10% or 20% of AC peak value and outputs as pulse
AC/DC Digital Clamp Meter	2009R*9	For high current (2000A/400A, DC/40 to 1kHz), Φ55, 0311-5184 signal input cable required
Clamp Adaptor	8112*10	For low current (20A/2A/0.2A, 40 to 10kHz), Φ8, 0243-3021 BNC adaptor required
AC/DC Clamp Sensor	8115*10	For low current (AC130A/DC180A, DC/40 to 1kHz), Φ12, 0243-3021 BNC adaptor required
Signal Input Cable for Clamp Meter	0311-5184*11	Length: 2m, miniature plug for microphone and insulated BNC connector

- *9 Use signal input cable (0311-5184) if connecting output from 2009R to RA3100.
 *10 Use BNC adaptor (0243-3021) if connecting output from 8112 or 8115 to RA3100.
 *11 Signal input cable to connect 2009R clamp meter to RA3100 insulated BNC connector.

Recording Paper		
Item	Model	Specifications
Recording Paper*12	Roll Paper	YPS106 219.5mm × 30m roll paper (5 rolls/box), Drawing No. 0511-3167
	Roll Paper (with perforation)	YPS108 219.5mm × 30m roll paper (5 rolls/box), perforation 300mm pitch, numbering 99 to 01, Drawing No. 0511-3166
	Z-fold Paper	YPS112 219.5mm × 201m Z-fold paper (1 set/box), folding width 300mm pitch, total of 670 sheets, Drawing No. 0511-3182

- *12 Quality not assured if paper other than above is used.

Peripheral Options		
Item	Model	Specifications
SD memory card 4G	RM11-453	4GB, industrial use (for saving setting conditions & measured data)
SD memory card 8G	RM11-454	8GB, industrial use (for saving setting conditions & measured data)
Z-fold Paper Storage Box	RA30-551	Including Z-fold paper adaptor RA12-301
Z-fold Paper Adaptor	RA12-301	
Recording paper holder	5633-1794	2 pcs/sets
Soft Carrying Case	RA23-183	
Hard Carrying Case with Casters	RA30-552	



萬和儀器有限公司

台中

Address: 台中市北區崇德路一段631號7樓之2 B
 室
 TEL: +886 4 22388896 FAX: +886 4 22388911

高雄

Address: 高雄市楠梓區大學二十街12號10樓
 TEL: +886 7 3650837 FAX: +886 7 3651613

Discover Precision

A&D Company, Ltd.

3-23-14 Higashi-Ikebukuro, Toshima-Ku, Tokyo, 170-0013, Japan Tel: +81 3-5391-6132 Fax: +81 3-5391-1566 <http://www.aandd.jp>

A&D Engineering, Inc.

1756 Automation Parkway, San Jose, CA 95131, U.S.A. Tel: +1 408-263-5333 Fax: +1 408-263-0119

A&D Korea Ltd.

8F Manhattan Bldg., 33, Gukjegeumyung-ro 6-gil, Yeongdeungpo-gu, Seoul, 07331, Korea Tel: +82 2-780-4101 Fax: +82 2-782-4280

A&D Technology Trading Co., Ltd.

32CD, World Plaza, No. 855 South Pudong Road, China (Shanghai) Pilot Free Trade Zone, 200120, China
 Tel: +86 21-3393-2340 Fax: +86 21-3393-2347

A&D Sciencetech Taiwan Ltd.

4F No. 5 Ching Tao East Road, Taipei, Taiwan, R.O.C. Tel: +886 2-2322-4722 Fax: +886 2-2392-1794